

Uniden®

BW515PTR

**Additional/Standalone Camera
Baby Monitoring System**

*For more exciting new products please visit our website:
Australia: www.uniden.com.au*

OWNER'S MANUAL

IMPORTANT SAFETY INSTRUCTIONS

This manual contains important information about this product's operation. If you are installing this product for others, you must leave this manual or a copy with the end user.

When using your equipment, always follow basic safety precautions to reduce the risk of fire, electric shock and injury to persons, including the following:

- **This equipment is NOT waterproof.** DO NOT expose it to rain or moisture.
- DO NOT immerse any part of the product in water. Do not use this product near water, e.g., near a bathtub, wash bowl, kitchen sink or laundry tub, in a wet basement or near a swimming pool.
- To avoid any risk of electric shock from lightning, avoid handling any electronic devices (except battery powered ones) during an electrical storm.
- Use only the power cord and/or batteries indicated in this manual.
- Never tug or pull on any power cord: be sure to leave some slack in the cord when placing your equipment, and always use the plug to unplug cord from the wall outlet.
- Never leave power cords where they can become crushed, cut, or frayed; when running power cords, avoid letting them rub against any sharp edges or lie across any high traffic areas where people might trip over them.
- Do not use the device if the adaptor cords or plugs have been damaged, the unit has been exposed to liquids, or the unit has been dropped or is damaged.

MAINTAINING YOUR SYSTEM

When dust and grime builds up on the camera lens and glass, it affects the camera's "vision." Use a microfiber cloth to regularly clean the cameras or when night vision video is cloudy or unclear.

Warning to Parents and Other Users

Failure to follow these warnings and the assembly instructions could result in serious injury or death. This product is not designed or intended for use as a medical monitor, nor should this product be used as a substitution for medical or parental supervision. Always be sure that both the transmitter and receiver are working properly, and are within range of each other.

STRANGULATION HAZARD. Keep the adaptor cords out of the reach of children.

WARNING: KEEP OUT OF THE REACH OF CHILDREN.

Allow for proper ventilation when units are in use. Do not cover the camera or receiver with any object such as a blanket. Do not place it in a drawer or in any location which would muffle the sound or interfere with the normal flow of air.

SAVE THESE INSTRUCTIONS!

For best results

To avoid damage to your equipment, follow these simple precautions:

- Do not drop, puncture or disassemble any part of the equipment. There are no user-serviceable parts inside.
- Do not expose the equipment to high temperatures, and avoid leaving the equipment in direct sunlight for more than a few minutes. Heat can damage the case or electrical parts.
- Do not place heavy items on top of the equipment or expose the equipment to heavy pressure.
- Remove the power adaptor during long periods between usages.
- Clean only with a dry cloth.

Failure to follow the instructions in this operating manual will void the warranty. Uniden assumes no liability for damages to property or injury to persons caused by improper handling or failure to comply with these safety instructions.

CONTENTS

WHAT'S IN THE BOX?	5
GETTING STARTED	6
INSTALLATION	10
CAMERA INSTALLATION	11
PAIRING TO THE MONITOR	13
USING THE BABY MONITOR	13
PAN AND TILT	13
SYSTEM MENUS	16
SPECIAL FEATURES	20
REMOTE VIEWING VIA APP	20
LIVE VIEW	25
HISTORY	26
TROUBLESHOOTING	27
SPECIFICATION	28
TWO-YEAR LIMITED WARRANTY	30

WHAT'S IN THE BOX?

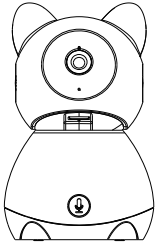

BW515PTR
Camera*

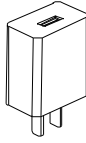

AC Adaptor

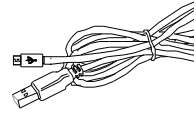

USB Cable



Reset Pin

- If any item is missing or damaged, contact your place of purchase immediately.
Never use damaged products!
- Need help? Get answers at our website:
www.uniden.com.au for Australian model

All trademarks are registered trademarks of their respective owners.

GETTING STARTED

Camera

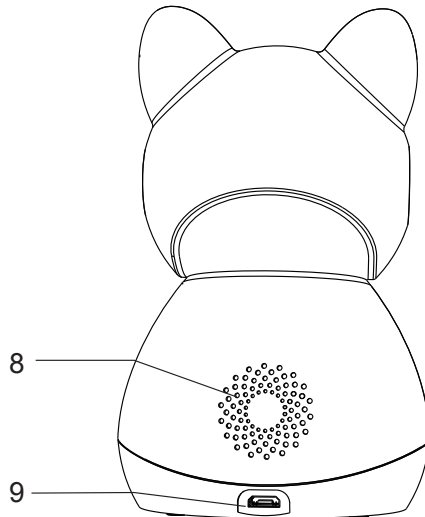
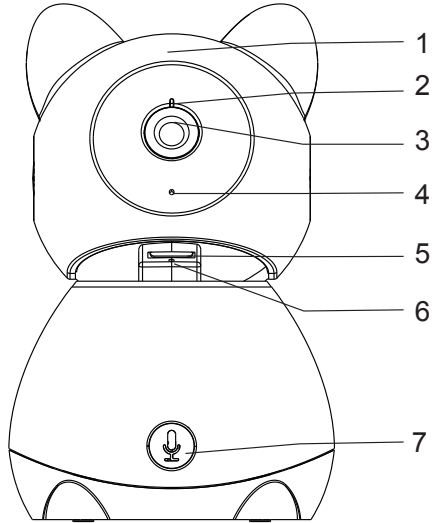

Item	What it does
1	Silicone Sleeve
2	<p>Status Light:</p> <p>Solid Red: Camera is malfunction.</p> <p>Slow Blinking Red: Waiting for network configuration.</p> <p>Fast Blinking Red: Fail to connect to the network/waiting for network connection.</p> <p>Solid Blue: Camera connected to the network.</p>
3	Lens: Camera lens.
4	Microphone: Captures sounds for the area near the camera.
5	MicroSD Card Slot: Insert microSD card (up to 128GB) to record video.
6	Reset: Insert and hold the reset pin until the prompt tone is heard to reset the camera.
7	PAIR: Press and hold until the prompt tone is heard to start pairing to the monitor.
8	Speaker: Produces the sound transmitted from the monitor.
9	USB Port: Connects the USB cable to the camera.

INSTALLATION

CAMERA INSTALLATION

Placement Considerations

The camera can be placed on a shelf or other flat surface.

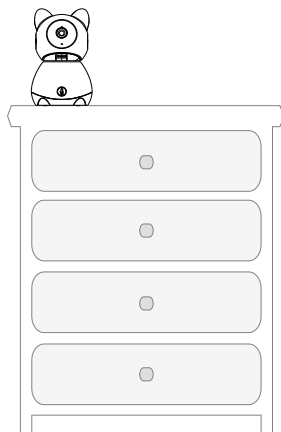
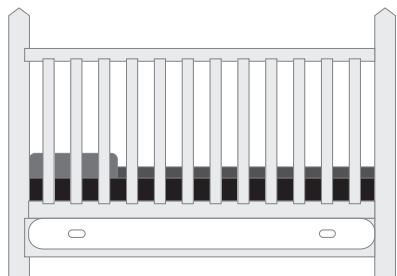

- The camera included is NOT weatherproof; it is an indoor camera.
 - Avoid having a direct light source in view of the camera (ceiling or floor lamps).
 - Carefully plan where and how the camera will be positioned, and where you will route the cable that connects the camera to the power adaptor.
 - If you are planning to pair it to a monitor, the clearest line-of-sight between the camera and monitor is best. Walls, especially brick and concrete, can affect reception quality.
 - When pairing to a monitor, to positioning the camera, bring the monitor along; it's much easier to get the camera into the right position when you have the display handy. Check the image on the monitor before you install the camera.
- 🔧 **You can install a maximum of 2 cameras to a BW51xx series monitor. When pairing the additional camera, you will need to pair the cameras with the monitor.**

Powering the Camera

Insert one end of the micro USB cable to the micro USB port on the camera (at the back of the camera).

Connect the other end of the USB cable into the USB power adaptor.

Connect the USB power adaptor into a 240 volt AC (standard indoor) power outlet.

Switch on the plug and allow the camera to power up.

PAIRING TO THE MONITOR

Pairing the camera to the monitor:

1. Press the **Menu** button on the monitor, and select  > **Camera Management** > **Camera icon that is greyed out** .

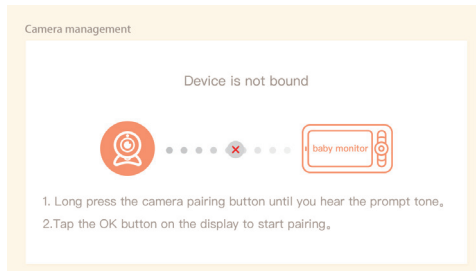

2. Press and hold the pairing button on the camera until you hear the prompt tone.



3. Press **OK** button on the display screen to start pairing.

Unpair the camera from the monitor:

1. Press the **Menu** button on the monitor, and select  > **Camera Management**.
2. Press and hold **OK** button on the monitor to unpair the camera.

The viewing range is limited to no more than 150m in line of sight. Other factors such as house walls, layout and electronic devices will affect the transmission range.

USING THE BABY MONITOR

Viewing the Camera on Monitor

After the camera is connected to the monitor, you may pan and tilt the camera (BW515PTR) to adjust the camera viewing angle for an ideal view.

On the live view page, press the  button on the monitor to rotate the camera horizontally and vertically.



BABY WATCH PLUS APP

REMOTE VIEWING VIA APP

You can download Uniden Baby Watch Plus app to remotely view the camera.

To set up the baby monitor camera, please make sure it's successfully installed and powered on, and that the status indicator on the camera is flashing red slowly.

The flashing RED (slow) status means that your camera is ready to be paired to the Baby Watch Plus App.

Prerequisites

- You must have an available Wi-Fi-enabled Smartphone (Android or iOS smartphone).
 - The BW515PTR camera and your smartphone must be within the same Wi-Fi network range for initial setup (ideally within 3m from the router).
 - Wi-Fi router connection is 2.4GHz and password if any.
1. Search and download the free Baby Watch Plus app from the App Store for iOS devices or Play Store for Android devices. You will need to create an account specifically for the Baby Watch Plus app. If you already have an account with Baby Watch Plus app, log in account and skip to Step 6.
 2. When the status indicator on the camera starts flashing red slowly, the camera is ready to be paired with the Wi-Fi network. If the status indicator is not red or flashing quickly, insert a pin to press and hold the reset button for 5 seconds, wait for the status indicator to flashing red slowly.

Press and hold for
5 seconds

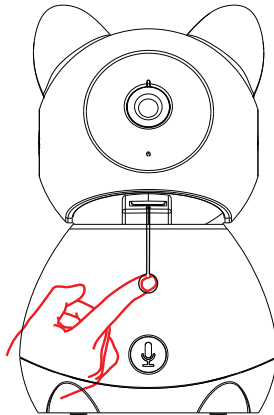

*** Please note that app screenshots are for reference only. User Interface for iPhone and Android Phones might differ in terms of icons layout and functionality and may change without notice.**

As the Baby Watch Plus app is constantly under development to enrich user experience, the icons/screens shown may vary slightly from the actual app.

2. When launch the Baby Watch app for the first time, you will see the login page. Tap the “Sign Up” button to create a new Baby Watch Plus account.

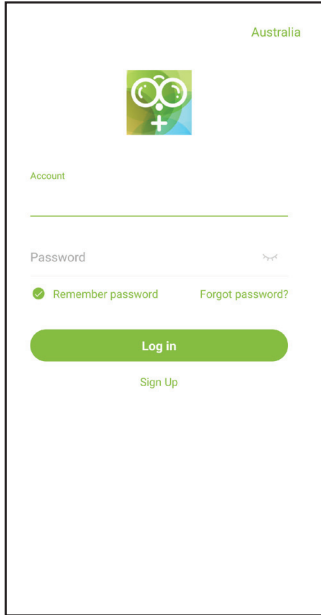

3. Enter your email address you wish to register with and check the user agreement privacy policies. Tap “Next” button to continue.

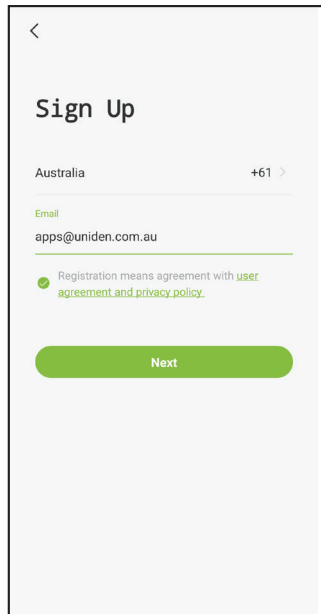

4. Name your account and enter your password. Tap Done button and you'll be all set. Your Baby Watch App account has now been created.

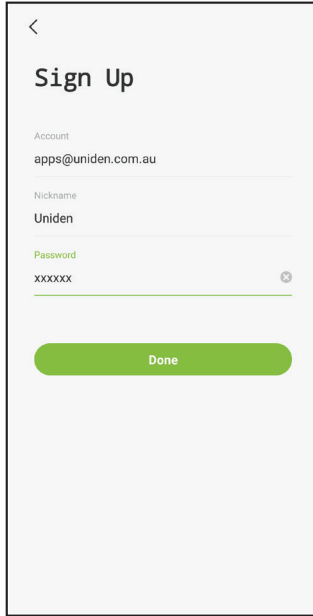

5. On the devices tab, to add a device, tap the “+” button on the middle of the screen or on the top right-hand side of the screen if you already have shared access or a paired device.

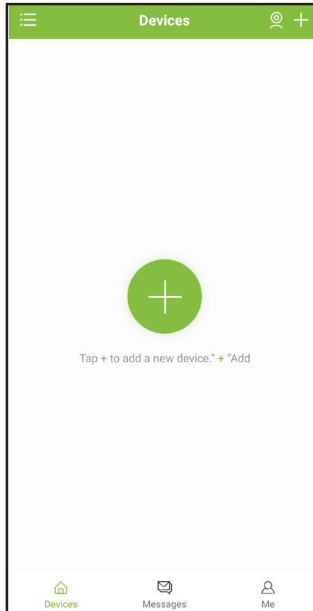

6. Please ensure the camera is powered on and is within the range of the router. Tap “Next” to continue. If the indicator light on the camera is not flashing slowly, press and hold the reset button with the reset pin for 5 seconds to reset the camera and set it up within 2 minutes. When the camera is flashing slowly, the camera is ready to set up tap “Next” to continue.

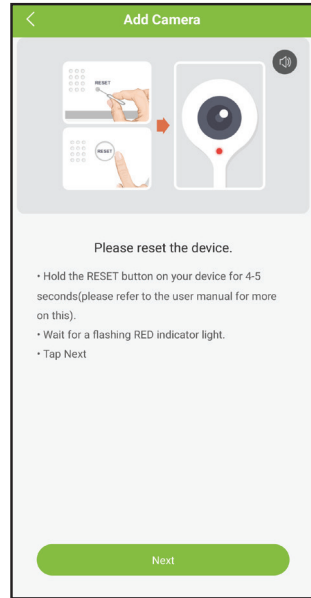
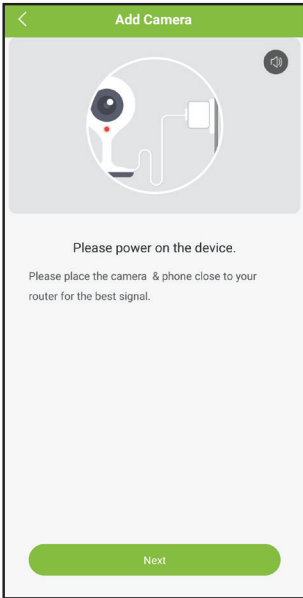

7. Enter the Wi-Fi password of the selected Wi-Fi network and tap “Next” to confirm the Wi-Fi name and password. Tap “OK” to continue. Please note that the camera only supports 2.4GHz Wi-Fi connection and the Wi-Fi SSID and password must not exceed 24 characters.

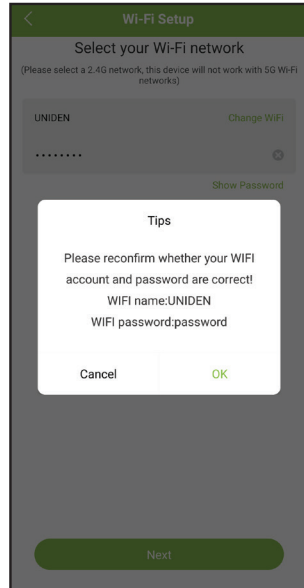
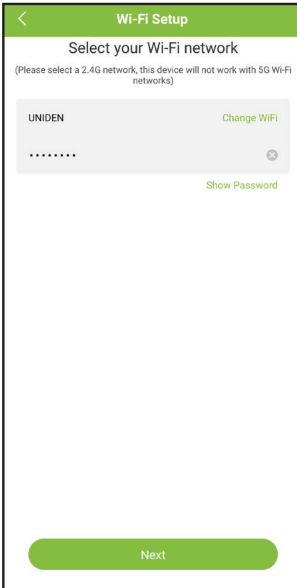

8. Please make sure that you've ripped the protection film off the camera's lens. Tap "Next" and a QR code will be generated on the screen. Please place the QR code on screen towards the camera lens at a distance of about 15~20cm to let the camera scan the QR code. After you hear the voice prompt from the camera, please press "Next" to continue.

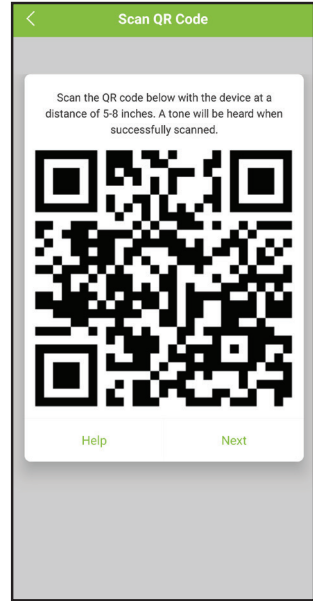
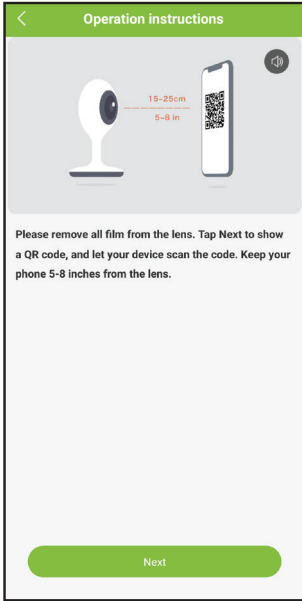

9. Please wait while the app is configuring your camera. Once completed, you'll be prompted to name your camera and tap "Done" to start the Live View.

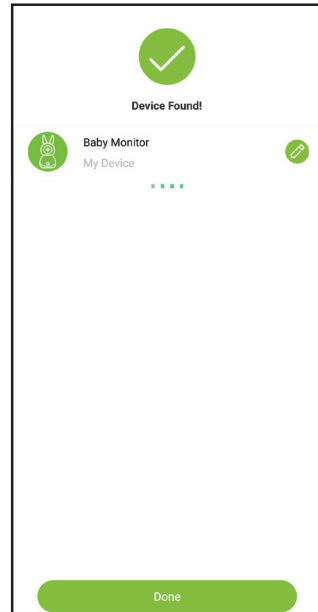
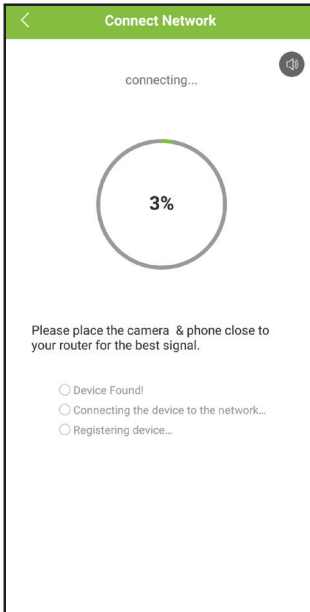

LIVE VIEW

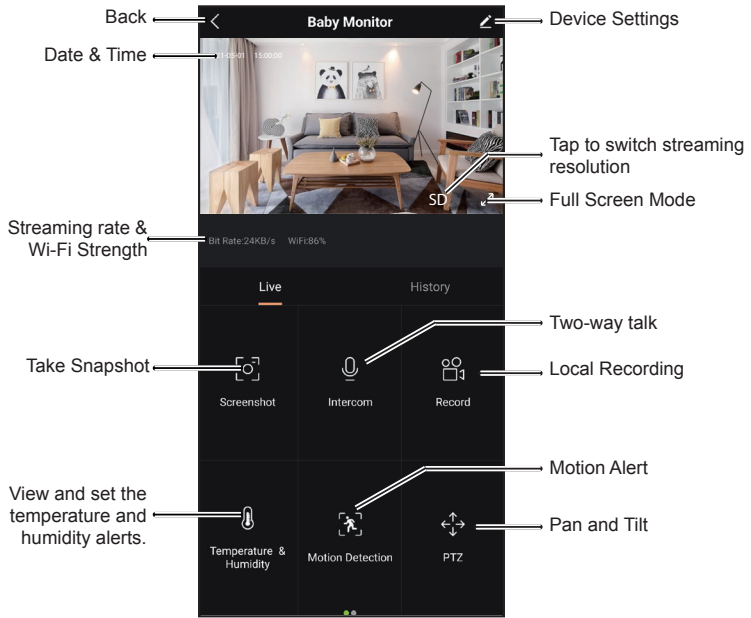

Scroll to the right.

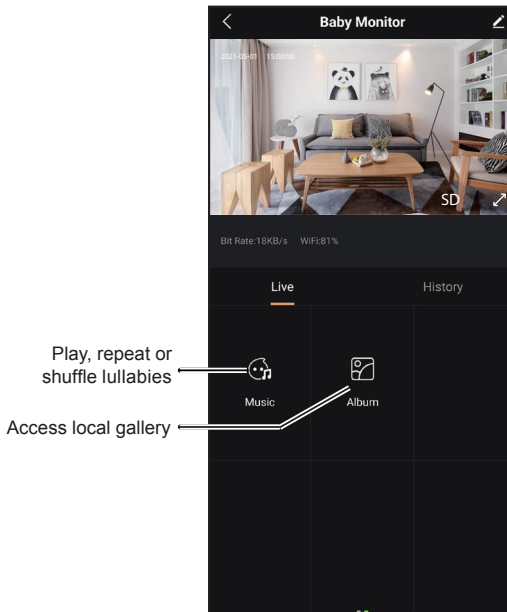

HISTORY

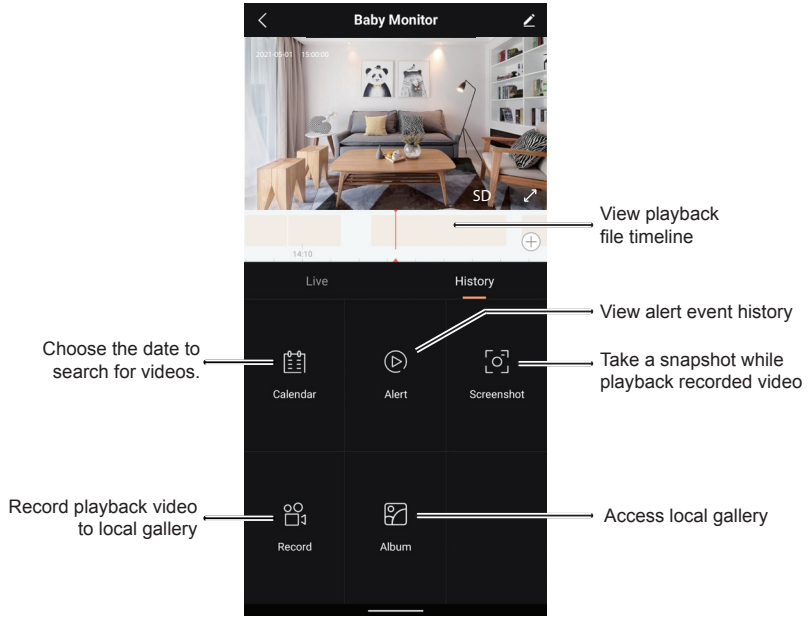

- ✂ Please note that a SD Card is needed and inserted to the camera for the lullabies to download and playback.
- ✂ Only the event recording and Full-Day recording are saved in the SD Card. Any event history is saved in the SD Card.
- ✂ Local recording and snapshot are saved to the phone gallery.

TROUBLESHOOTING

If you have problems with the system, there is often a quick and simple solution. Please try the following:

If	Try
There is no picture on the monitor from the camera	<ul style="list-style-type: none"> • checking all connections to the camera. Make sure the adaptor is plugged in. • making sure that the cameras and monitor are both ON. • making sure that the camera is in range of the monitor.
The picture keeps dropping on the monitor	<ul style="list-style-type: none"> • moving the camera closer to the monitor. • repositioning the camera, monitor or both to improve the reception. • adjusting the monitor antenna to vertical position.
There are audio problems	<ul style="list-style-type: none"> • making sure that there is sound within range of the camera microphone. • moving the camera or monitor farther apart if the unit emits a loud screeching noise.
There is an irregular beeping coming from the monitor	That is the Alert tone. Go to the Alert screen to turn the alert volume down or off .
The picture has become choppy	<p>The picture may become choppy when experiencing a lower frame rate. Try:</p> <ul style="list-style-type: none"> • moving the camera closer to the monitor. • removing obstructions between the monitor and camera. • adjusting the monitor and antenna to vertical position.
The monitor picture has frozen	Use the reset pin included to reset the monitor. The monitor turns off. Press POWER to turn it back on again.
You can't record video or take a snapshot	Ensure a micro SD Card is inserted and format the SD card with the system. The SD Card needs to be FAT32 format.
The camera is not found when setting up or could not connect to the router.	<p>Make sure the Wi-Fi router supports DHCP protocol and the option is turned on.</p> <p>Make sure the camera and your mobile device connect to the same Wi-Fi router and selected the correct 2.4GHz Wi-Fi SSID and entered the correct password.</p>

SPECIFICATION

CAMERA

Image Sensor	1/2.9" Colour CMOS
Video Resolution	1920 x 1080
Rotation Angle	Pan:0~355° Tilt: 0°~60°
Viewing Angle	105°
Two-way Audio	Yes
Night Vision	Up to 10m
Temperature Sensor	Yes
Humidity Sensor	Yes
Wi-Fi	2.4G WIFI (IEEE802.11b/g/n)
Transmission Range	Wi-Fi: up to 50m line of sight Monitor: up to 150m Line of sight
Smart Home	Google Assistant / Alexa
Storage	Supports up to 128GB micro SD Card
Power Input	5V/1A
Operating Temperature Range	-10°C ~ 40°C (14°F ~ 104°F)
Operating Humidity Range	Within 80% Relative Humidity

TWO-YEAR LIMITED WARRANTY

BW515PTR

IMPORTANT Satisfactory evidence of the original purchase is required for warranty service. Please refer to our Uniden website for any details or warranty durations offered in addition to those contained below.

Warrantor

The warrantor is Uniden Australia Pty Limited ABN 58 001 865 498 (“Uniden Aust”).

Terms of Warranty

Uniden Aust warrants to the original retail purchaser only that the BW515PTR Series (“the Product”), will be free from defects in materials and craftsmanship for the duration of the warranty period, subject to the limitations and exclusions set out below.

Warranty Period

This warranty to the original retail purchaser is only valid in the original country of purchase for a Product first purchased either in Australia or New Zealand and will expire, as indicated below, from the date of original retail sale.

Product	2 Year
Accessories	90 Days

If a warranty claim is made, this warranty will not apply if the Product is found by Uniden to be:

- (A) Damaged or not maintained in a reasonable manner or as recommended in the relevant Uniden Owner’s Manual;
- (B) Modified, altered or used as part of any conversion kits, subassemblies or any configurations not sold by Uniden Aust;
- (C) Improperly installed contrary to instructions contained in the relevant Owner’s Manual
- (D) Repaired by someone other than an authorized Uniden Repair Agent in relation to a defect or malfunction covered by this warranty; or
- (E) Used in conjunction with any equipment, parts or a system not manufactured by Uniden.

Parts Covered

This warranty covers the Product and included accessories.

User-generated Data

This warranty does not cover any claimed loss of or damage to user-generated data (including but without limitation phone numbers, addresses and images) that may be stored on your Product.

Statement of Remedy

If the Product is found not to conform to this warranty as stated above, the Warrantor, at its discretion, will either repair the defect or replace the Product without any charge for parts or service. This warranty does not include any reimbursement or payment of any consequential damages claimed to arise from a Product's failure to comply with the warranty.

Our goods come with guarantees that cannot be excluded under the Australian Consumer Law. You are entitled to a replacement or refund for a major failure and for compensation for any other reasonably foreseeable loss or damage. You are also entitled to have the goods repaired or replaced if the goods fail to be of acceptable quality and the failure does not amount to a major failure.

This warranty is in addition to and sits alongside your rights under either the COMPETITION AND CONSUMER ACT 2010 (Australia) or the CONSUMER GUARANTEES ACT (New Zealand) as the case may be, none of which can be excluded.

Procedure for Obtaining Warranty Service

Depending on the country in which the Product was first purchased, if you believe that your Product does not conform with this warranty, you should deliver the Product, together with satisfactory evidence of your original purchase (such as a legible copy of the sales docket) to Uniden. Please refer to the Uniden website for address details. You should contact Uniden regarding any compensation that may be payable for your expenses incurred in making a warranty claim. Prior to delivery, we recommend that you make a backup copy of any phone numbers, images or other data stored on your Product, in case it is lost or damaged during warranty service.

UNIDEN AUSTRALIA PTY LTD

Phone number: 1300 366 895

Email address: custservice@uniden.com.au

Uniden[®]

©2021 Uniden Australia Pty Ltd
Printed in PRC v1.0