

Uniden®

DASH VIEW 50/50R **Dash Cam** **Vehicle Recorder**

For more exciting new products please visit our website:
Australia: www.uniden.com.au

OWNER'S MANUAL

Important Safety Instructions



NOTE

Uniden does not represent this product to be waterproof. Do not expose this product to Rain or Moisture.



NOTE

This product is intended for use in a motor vehicle. Don't install the device where it will block the driver's view of the road (including the mirrors!) or the deployment of the airbag.



NOTE

Keep your attention on the road! Don't try to operate or focus on any device while driving. If you have to concentrate on a device, pull off the road for a few minutes.



NOTE

Ensure that the camera lens is kept clean and there is nothing blocking the lens.



NOTE

Don't leave the device in direct sunlight for a long period of time or where the temperature could go above 60°C.



NOTE

You should examine, check and/or verify the device at least once a month including the associated SD card, to ensure the recording are working properly.



NOTE

Never attempt to disassemble, repair or make any modifications to your device.

Contents

Important Safety Instructions	2
What's In The Box.....	4
Make Sure These Items Arrived in the Box	4
Controls & Indicators	5
Installation	7
Location	7
Installing the Camera	7
Installing the Rear Camera	8
Installing the Optional Hardwiring Kit	8
Operation	9
Micro SD Card	9
GPS Reception Information	9
Power On	10
Power Off	10
Recording	11
Using the App	12
Device Settings	16
Uniden Player	19
Troubleshooting	21
Specification	22
Warranty	23

What's In The Box

Make Sure These Items Arrived in the Box



Uniden Dash View 50
with sticker mount
bracket attached



64GB MLC High
Endurance Micro
SD Card



Cigarette Charger



Hardwiring Kit



Micro USB
data cable



Rear Camera with sticker mount
(Uniden Dash View 50R Only)

- Protection film
 - Sticker mount bracket
 - Owner's Manual
- If any item is missing or damaged, contact your place of purchase immediately. ***Never use damaged products!***
 - Need help? Get answers at our website:
www.uniden.com.au for Australian model.

Controls & Indicators

Uniden Dash View 50

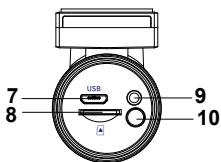
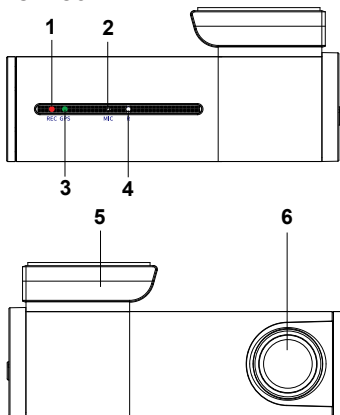

Rear Camera (Uniden Dash View 50R only)

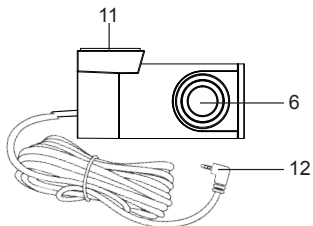

Ref	Component	Description
1	REC LED	Flashing RED when the device is recording
2	MIC	Records sound.
3	GPS LED	Solid Green when the device GPS is connected.
4	Speaker / Reset	If the device fails to operate properly, try resetting the device. Press the reset button by using a fine pen or paperclip.
5	Bracket Slot	Slot in the sticker mount bracket.
6	Camera Lens	
7	Micro USB Port	Insert DC car charger micro USB cable or the Hard wiring kit micro USB connector. Connect to PC for data (SD card) transfer.
8	Micro SD Card Slot	Insert micro SD Card (up to 256GB min Class U3).
9	AV In Port	Insert optional rear camera AV connector.
10	Smart One Touch Button	Press one time to start event recording. Press two times to turn on/off audio recording. Press and hold 5 seconds to switch On/Off Wi-Fi access point. Press and hold 10 seconds to format SD card. Press one time to access SD card files when connected to PC.
11	3M Sticker	
12	AV Connector	Connect to the front camera AV In Port.

Installation

Location

To have a better view, try to install the camera at the center of the windshield. Make sure the lens is located in a place where the windshield is clean to ensure the view is clear.

Make sure the device is not installed in a place where it will interfere with the airbag. Make sure the GPS will not be obstructed by the windshield's sun control film (window tint).

Installing the Camera

1. The sticker mount bracket comes pre-installed with the camera. Otherwise, slot the sticker mount bracket into the device bracket slot and make sure it fits tightly.
2. Clean the area you desire to have the dash cam placed before sticking the device.
3. Peel off the 3M sticker protective film from the mount bracket.
4. Press and apply force on the mount onto the windshield behind the rear-view mirror.
5. Arrange and hide the cables to avoid obstruction for the driver's view.
6. Adjust the viewing angle of the camera by rotating the body of the camera. We recommend the camera should point slightly downwards $\sim 10^\circ$ below eye level.



NOTE

Do not install the product in a location where it can obstruct the driver's field of vision.

Installing the Rear Camera

Install the rear camera at the centre top of the rear windshield.

1. Clean the area before installation.
2. Peel off the sticker protective film from the 3M sticker.
3. Press and apply force on the sticker mount onto the back windshield. The AV cable outlet needs on the left side in the car facing forward direction.
4. Connect the rear camera to the front camera with the AV cable.
5. Arrange and hide the cables to avoid obstruction for the driver's view.
6. Adjust the viewing angle of the camera by rotating the body of the camera. We recommend the camera should point slightly downwards $\sim 10^\circ$ below eye level.

Installing the Optional Hardwiring Kit

If you wish to use the parking mode on the camera, you will need to install the hardwiring kit provided.

1. Locate the location of the fuse box in your vehicle.
2. There are 3 wires that need to be connected: connect the **Yellow** cable that goes to a constant fuse, **RED** cable that goes to an ignition-switched fuse and **BLACK** cable that goes to a metal ground bolt.

YELLOW cable connect to **BATTERY (+)**

RED cable connect to car **ACC**

BLACK cable connect to car **GROUND**

3. Connect the micro USB end of the hardwiring cable to the camera micro USB port.
4. Start your vehicle to see if it works. Arrange and hide the cables to avoid obstruction for the driver's view.

It is advisable to get a car electrician to professionally install the hardwiring kit.



NOTE

Before installing the HWK-1R, please ensure there is no SD Card installed on the camera unit. Only install the SD card once the HWK-1R is finish installing.

Operation

Micro SD Card

The device support micro SDXC cards (Extended Capacity SD) up to 256GB in capacity. A micro SD card of at least 32GB capacity and minimum speed of Class U3 is required.

Insert a the micro SD card gently in the slot at the side of the unit and press and hold the **Smart One Touch** button for 10 seconds for the voice prompt to format the micro SD Card for first use. To remove the card from the slot, please ensure the unit is powered off and press the edge of the micro SD card inwards for it to pop out and then pull it out of the slot.

It is important to format the micro SD card before using it, so as to avoid any damage to the files created on DASH VIEW 50/50R.

Uniden only recommends using good quality MLC/SLC Endurance micro SD cards for dash cam recording. Please check with SD card manufacturer to ensure that the SD card used is rated for Dash Cam recording.

Video Storage Capacity

Refer to the table below for reference for the recording time for different card capacity and some of the recording resolution.

Resolution	32GB	64GB	128GB	256GB
2160P 30fps+ 1080P 30fps H.265	90 mins	180 mins	360 mins	720 mins
1080P 30fps+ 1080P 30fps H.265	120 mins	240 mins	480 mins	960 mins



A compatible micro SD card has to be inserted before you start using the unit. Ensure that the unit is switched off before inserting or removing the micro SD card.

GPS Reception information

Surroundings with tall buildings, tunnels or poor weather conditions may result in poor GPS reception or even lose GPS signal. Over-tinting or a rain sensor on the windshield can affect GPS reception.

If the signal is unstable even when you are driving, please try changing the installation spot of your dash camera. For the first time use, it takes about 15~20 minutes to get GPS signal, and after that, it normally takes about 3 minutes.



Sticker mount is difficult to remove after it is installed and will not stick well on a curved/textured or wet surface.

Power On



NOTE

When connected to a car charger with power, the camera will automatically power on and start recording.

1. Connect the other end of the DC car adaptor to your car's cigarette lighter.
2. Connect the DC car micro USB adaptor to the power connector USB port found on the camera.
3. The camera will power on automatically when the car supplies the power to the camera.
4. The RED led on the camera will start flashing and recording starts automatically.



NOTE

Be sure insert the SD card before powering up the device. Format the SD card before you start recording for the first time.

Power Off

When the car's engine is turned off, the device will automatically turn off in a few seconds.

Power Information

The device is designed mainly for in-vehicle use, drawing on vehicle power or the vehicle battery when using the hardwiring kit (HWK-1R).

The Dash VIEW 50/50R has an in-built high quality, long life supercapacitor. It provides enough backup power to ensure any recording in progress is stored safely before shutting the camera off.



NOTE

For the first time use, it is advisable to format the SD Card. Press and hold the **Smart One Touch** button for 10 seconds to format the SD Card.

Recording

When connected to a car charger with power, the unit automatically goes into the record mode and starts recording.

A flashing RED led on the device indicates that the device is recording.



NOTE

To record a video, ensure that a valid micro SD card is inserted in the given slot. Also note, that inserting/removing the SD card when the device is recording causes the device to shutdown and in worst case missing recording files.

Protect the Current Recording

While recording, if you want to protect the current recordings, then press the **Smart One Touch** button ONCE. Those recordings have been locked and will not be overwritten by normal video recordings.

This also applies when the G-Sensor registers an impact while recording.

Using the App

The Uniden Dash View app allows you to control the Dash View camera via WiFi. You can easily preview, browsing files, playback and download the files in the SD card into your mobile phone. The app also allows you to make changes to the device setting.

The Dash View camera WiFi access point is On by default. You can confirm this with the **Smart One Touch Button** is glowing blue.



NOTE

Connect your mobile phone to your Dash View within a line of sight range of 10m.



NOTE

Press and hold the WiFi button for 5 seconds to turn on/off the WiFi access point.

1. Search and download the “Uniden Dash View” App from the App Store for iOS devices or Play Store for Android devices.
2. Go to your mobile phone WiFi setting and connect to the camera's access point. The SSID usually starts with DASHVIEW_.... and the default password is 12345678.
3. Go to the Dash View app and tap the camera.



NOTE

If issue arises from accessing the camera via APP for the first time, please format the SD Card by press and hold the **Smart One Touch** button for 10 seconds.

Home Screen

When your mobile phone is connected to the camera's WiFi access point, the camera image will show on the home screen.

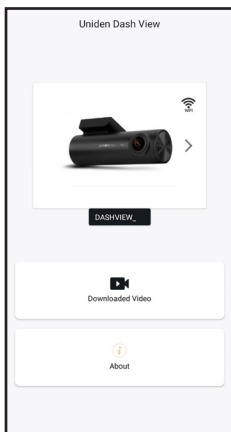

Camera is connected

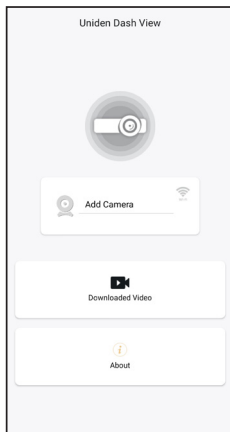

Camera is not connected

Camera

Tap to view live video stream from the camera, take a snapshot, and view camera settings.

Downloaded Video

Tap the Downloaded Video tab to view or playback downloaded photos or videos even when then the camera is not connected.

About

Tap to view app information or clear app cache data.

Live View

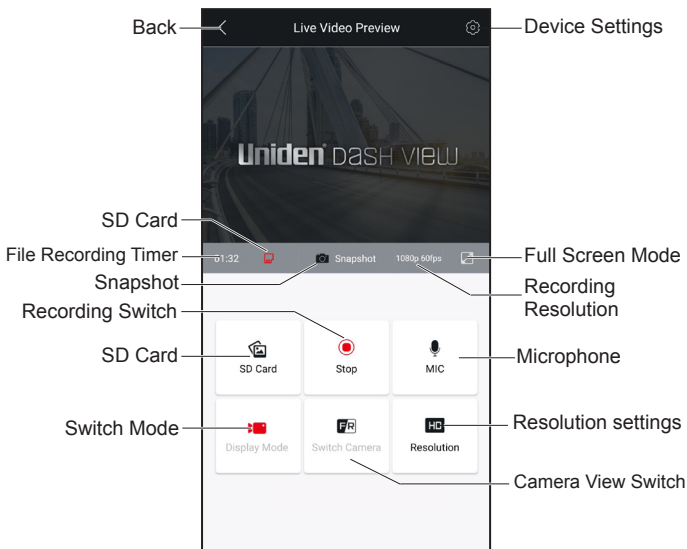

Back

Return to home screen.

SD Card

When SD card is not inserted, it will indicate "No Card".

File Recording Timer

Indicates the loop recording timer.

Snapshot

Take a quick snapshot and save to the SD card.

Recording Switch

Start/stop the connected camera recording.

SD Card

Tap the SD Card to access the saved snapshots or videos onto the SD Card. You can tap to the video file to play directly or download the video file to the mobile phone storage.

Display Mode

Not applicable for Dash VIEW 50/50R series camera.

Camera View Switch

Switch camera view between front and rear camera.

Resolution Settings

Tap to change the recording resolution. You will need to stop the recording to make changes.

Microphone

Turn on/off the connected camera audio recording.

Recording Resolution

Indicates the selected recording resolution.

Full Mode

Tap to view live video preview in full screen mode.

Device Settings

Modify camera settings.



NOTE

You can change WiFi SSID and password in the Camera Settings using the app.

Device Settings



NOTE

Please note that to access the Device Settings, the device required to stop recording.

Pair your mobile phone with the Dash View camera and go to live view screen. Stop the recording and tap the device settings icon to access settings menu. Any changes to the settings will take effect concurrently.

Video Settings	
Resolution	Set the recording resolution for the front camera. The options available are: 3840x2160P 30fps, 2560x1440P 30fps, 1920x1080P 30fps and 1280x720P 30fps. Higher resolutions will give you a sharper image, but take up more memory on the card. The rear camera resolution is fixed at 1920x1080P 30fps.
Loop Recording	Use this option to set the length of each video clip.
WDR	Turn on/off the Wide Dynamic Range (WDR) feature to improve the overall exposure throughout your entire image.
Time Stamp	Opt to have the date and time displayed on the recordings.
GPS Stamp	Opt to have the GPS coordinates displayed on the recordings.
Audio Recording	Use this setting to enable or disable audio recording.
Volume	Adjust the camera volume level.
Anti-Flicker	Change depending on the electrical power frequency in your area (Default setting is 50Hz and you may not have to change this setting).

Other Settings	
Camera Alert	Set the alert distance when there is a Fixed Speed, Red Light or Red Light-Speed Camera.
Parking Mode	<p>Parking mode settings will only appear when the unit powered with the optional Hard Wire Kit (HWK-1R). The unit must have sufficient external power supplied in order to record in parking mode.</p> <p>1S1FPS: After the ACC current is cut off, the unit will enter time-lapse recording mode (1 fps and playback in 30fps).</p> <p>Normal: This mode turns on the unit if it detects impact and will record for 60 seconds.</p> <p>Motion Detection: After the ACC current is cut off, the unit will enter standby mode and record for 60 seconds when motion detected.</p>
G-Sensor	This functions helps protect/lock video files in case of a sudden movement/collision. You can change the sensitivity level of the G-sensor.
Voice Control	Enable or disable this feature to use voice commands to operate the camera
Voice Command	<p>List of commands recognised by the camera.</p> <p>Switching WiFi On/Off: "Uniden, Turn On WiFi" / "Uniden, Turn Off WiFi"</p> <p>Take a snapshot: "Uniden, Take picture"</p> <p>Lock the current recording file: "Uniden, Lock the video"</p>
Time Sync	Sync the device time with the mobile phone time.
Time Zone	Set the correct time zone for the GPS to get the correct time settings for the device. GPS time will overwrites any time synced with the mobile phone.
Daylight Saving	Enable or disable daylight saving time.
GPS Information	To view the GPS signal connection status and strength.

Car Plate Stamp	Tap to edit the car plate stamp.
Storage Information	Indicates the remaining capacity of the inserted micro SD card.
Format SD Card	Use this option to format the SD card. (All files will be permanently erased.)
Factory Default Settings	Resets the device to factory settings. Note that restoring defaults will not erase data on the SD card.
WiFi Name	Tap to view or rename the WiFi access point name.
WiFi Password	Tap to view and change the password for the WiFi access point.
Device Information	Display the device firmware version.

Connecting to a PC

The Dash View camera can be connected to a PC (plug the USB data cable into the micro USB port). You can view the SD card contents on the PC. When the device is detected on the PC as an external drive, the normal recording video files can be found in the Movie folder. All the event recording files are stored in the EMR folder.

Uniden Player

Uniden Player allows you to view the recordings on the Dash View camera and trace them on a map. The software is supported on Windows 7, Windows 8 Windows 10 and on macOS.

Installing Uniden Player

Download the Uniden Player from the Uniden website. You may need to unzip the file using the appropriate archiving software before you can use the player. Double click on the Uniden Player icon.

Access the Recorded Files

Before playing the recorded files on the Uniden Player, ensure that you can access the files easily.

Either remove the micro SD card from the recorder, and access the card (files) on the computer via a card reader.

or

Connect one end of the micro USB data cable to the camera and the other end to the USB port on your computer and then press the **Smart One Touch** button on the camera to access the SD Card files.

View the Recorded Files

To view the recorded files on the Uniden Player, follow the steps below:

1. Start the Uniden Player (i.e., double click on the Uniden Player icon on your desktop, or click windows start and search from the program listing).

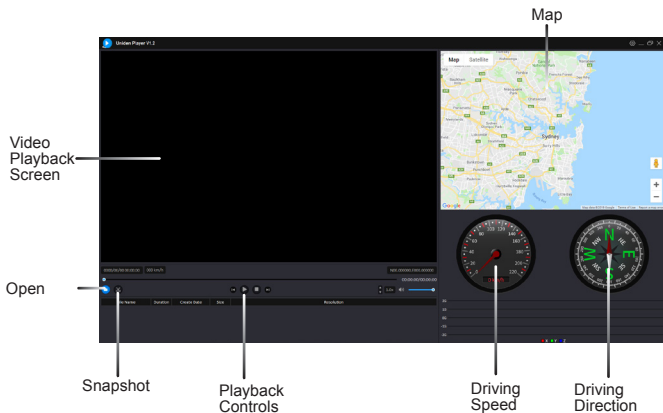

Ensure that the PC is connected to the internet to view the map screen.

2. Click on the Open icon to open the files on to the Uniden Player.

3. Click on the PLAY button (Playback Controls) to start playback.

Click on the 'Snapshot' icon to take photos of the recording. These photos will automatically save into a folder named 'screenshot'. This folder is located in the Uniden Player folder stored in your PC.



NOTE

Uniden Player version is subject to change without notice. See Uniden website to download the latest GPS Player.

Troubleshooting

Listed below are some of the problems and the possible solutions.

General Problems	Possible Solutions
The device cannot take snapshot or record videos	<ul style="list-style-type: none">• Ensure that the SD card is formatted properly and inserted correctly.• Use the recommended type of SD card (minimum 32GB Class U3)
The device automatically stops when recording	
Video is unclear	Ensure that there are no fingerprints or dirt on the lens. Ensure that the lens is always kept clean.
Cross-stripe interference in an image	This is due to the light frequency. Change the light frequency depending on the light source.
The device crashes/ freezes	Press the 'Reset' button, with a pin, to restart the device.
SD Card Error	Please format the SD card and use recommended card only. Please make sure the SD card is recommended dash cam use.
Display turns off after a few minutes	Please check the LCD Auto Off setting and select Always On.
Memory card is full	Please allow loop recording to overwrite older recording files or delete unwanted files including emergency recordings.
Camera feels warm during operation	It is normal for the camera to get warm during operation. Please bear in mind that the if the camera is exposed to high temperature for a long period of time, it might fail to boot up. Cool it down and try again.
The recorded video doesn't show mapping information on the Uniden Player.	Please ensure the PC is connected to internet.

If you still require assistance, visit our website or call our customer service.

Specification

Sensor Type	Front: 1/2.8" CMOS
Video Resolution	3840x2160/2540x1440/1920x1080/1280x720
Frame Rate	30fps
Photo Resolution	8M/4M/3M/2M/1M
Loop Recording	Yes
Audio Recording	Yes
Viewing Angle	150°(front) / 140°(rear)
WDR	Yes
GPS	Built-In
Date and Time Stamp	Yes
Motion Detection	Yes
Parking Mode	Yes (requires HWK-1R)
G-Sensor	Yes
Video Format	MP4
Video Codec	H.265
Audio Codec	AAC
WiFi Access Point	2.4GHz (up to 10m line of sight)
Storage	microSD (up to 256GB), Class U3 and above
Power Input	5V 2.0A
Supercapacitor	5.5V 2.5F
Operating Temperature	-10°C ~ 60°C
Storage Temperature	-20°C ~ 70°C
Working Humidity	10 ~ 80%

Warranty

UNIDEN DASH VIEW 50/50R

IMPORTANT: Satisfactory evidence of the original purchase is required for warranty service

Please refer to our Uniden website for any details or warranty durations offered in addition to those contained below.

Warrantor: The warrantor is Uniden Australia Pty Limited ABN 58 001 865 498 ("Uniden Aust").

Terms of Warranty: Uniden Aust warrants to the original retail purchaser only that the DASH VIEW 50/50R ("the Product"), will be free from defects in materials and craftsmanship for the duration of the warranty period, subject to the limitations and exclusions set out below.

Warranty period: This warranty to the original retail purchaser is only valid in the original country of purchase for a Product first purchased either in Australia or New Zealand and will expire one (1) year from the date of the original retail sale.

If a warranty claim is made, this warranty will not apply if the Product is found by Uniden to be:

- (A) Damaged or not maintained in a reasonable manner or as recommended in the relevant Uniden Owner's Manual;
- (B) Modified, altered or used as part of any conversion kits, subassemblies or any configurations not sold by Uniden Aust;
- (C) Improperly installed contrary to instructions contained in the relevant Owner's Manual
- (D) Repaired by someone other than an authorized Uniden Repair Agent in relation to a defect or malfunction covered by this warranty; or
- (E) Used in conjunction with any equipment, parts or a system not manufactured by Uniden.

Parts Covered: This warranty covers the Product and included accessories.

User-generated Data: This warranty does not cover any claimed loss of or damage to user-generated data (including but without limitation phone numbers, addresses and images) that may be stored on your Product.

Statement of Remedy: If the Product is found not to conform to this warranty as stated above, the Warrantor, at its discretion, will either repair the defect or replace the Product without any charge for parts or service. This warranty does not include any reimbursement or payment of any consequential damages claimed to arise from a Product's failure to comply with the warranty.

Our goods come with guarantees that cannot be excluded under the Australian Consumer Law. You are entitled to a replacement or refund for a major failure and for compensation for any other reasonably foreseeable loss or damage. You are also entitled to have the goods repaired or replaced if the goods fail to be of acceptable quality and the failure does not amount to a major failure.

This warranty is in addition to and sits alongside your rights under either the COMPETITION AND CONSUMER ACT 2010 (Australia) or the CONSUMER GUARANTEES ACT (New Zealand) as the case may be, none of which can be excluded.

Procedure for obtaining warranty service: Depending on the country in which the Product was first purchased, if you believe that your Product does not conform with this warranty, you should deliver the Product, together with satisfactory evidence of your original purchase (such as a legible copy of the sales docket) to Uniden. Please refer to the Uniden website for address details. You should contact Uniden regarding any compensation that may be payable for your expenses incurred in making a warranty claim. Prior to delivery, we recommend that you make a backup copy of any phone numbers, images or other data stored on your Product, in case it is lost or damaged during warranty service.

UNIDEN AUSTRALIA PTY LTD

Phone: 1300 366 895

Email: custservice@uniden.com.au

Uniden[®]

© 2022 Uniden Australia Pty Limited.
Printed in China v1.0