



Uniden®



UH820 series
Handheld UHF-CB Transceiver

For more exciting new products please visit our website:
Australia: www.uniden.com.au

OWNER'S MANUAL





Warning

LITHIUM ION BATTERY PACK WARNING

- This equipment contains a Lithium Ion Battery Pack.
- The Lithium Ion Battery Pack contained in this equipment may explode if disposed of in a fire.
- Do not short-circuit the Battery Pack.
- Do not charge the Lithium Ion Battery Pack used in this equipment in any charger other than the one designed to charge this Battery Pack. Using another charger may damage the Battery Pack or cause the Battery Pack to explode.
- Lithium Ion batteries must be disposed off properly.



NOTE

USER LICENSE INFORMATION

The citizen band radio service is licensed in Australia by ACMA Radio-communications (Citizen Band Radio Stations) Class Licence and in New Zealand by MED General User Licence for Citizen Band Radio and operation is subject to conditions contained in those licenses.



Contents

| | |
|---|-----------|
| Introduction | 4 |
| Included in your Package | 5 |
| Controls and Indicators | 6 |
| Getting Started | |
| Connect Drop-in Charger with the AC Adaptor | 7 |
| Attaching the Antenna | 7 |
| Attaching the Battery Pack | 8 |
| Attaching the Beltclip | 8 |
| Charging the Battery Pack | 9 |
| Battery Level Display | 10 |
| Accessory Jack Cover | 11 |
| Connecting the SPKR/MIC | 11 |
| Operation | |
| Power On/Off | 12 |
| Volume | 12 |
| Setting the Squelch | 12 |
| Selecting Channel | 13 |
| To Transmit and Receive | 13 |
| To Operate in Duplex Mode | 14 |
| Transmit Power Select | 15 |
| Smart-key Function | 15 |
| Scanning | 15 |
| Open Scan (OS) Mode | 17 |
| Group Scan (GS) Mode | 18 |
| Priority Channel | 19 |
| Drop-Out Delay | 19 |
| Instant Priority Channel | 19 |
| Monitor | 20 |
| CTCSS | 20 |
| DCS | 21 |
| VOX | 21 |
| Busy Channel Lock-out (BCL) | 22 |
| Call Tone | 22 |
| Roger Beep | 23 |
| Key Beep | 23 |
| Keypad Lock | 24 |
| Backlighting | 24 |
| CTCSS Codes and Frequencies | 25 |
| DCS Codes Table | 26 |
| UHF-CB Channel Guidelines | 27 |
| UHF-CB Channels and Frequencies | 28 |
| Warranty | 30 |



Introduction

The UH820 Series is a portable two-way UHF-CB radio. Its compact, rugged and fits easily on your hand. This hand held UHF-CB radio will give you consistent, outstanding performance in general conditions and situations. To ensure that you get the most from the radio features, please read this operating guide carefully before using the unit.

FEATURES

- Designed and Engineered in Japan
- 80 Narrowband Channels¹
- 2.0 Watt Maximum TX Output Power
- Long Life 1600mA Lithium-ion Battery
- One-Touch Smart Key
- Range Extender (Duplex) Capability
- VOX Hands Free Capable
- Interference Eliminator (CTCSS)
- Digital Coded Squelch (DCS)
- Backlit LCD Display
- Auto Battery Save
- Open Scan
- Group Scan
- Rapid scan speed
- Battery Level Indicator
- Busy Channel Lockout Function
- Roger Beep
- Keypad Lock

¹ Refer to p.27 - p.29 for channel information





Included in your Package

| ITEM | UH820 | UH820-2 |
|-------------------------------------|-------|---------|
| UH820 UHF Radio | 1 | 2 |
| 1600mAh Li-Ion Battery Pack (BT820) | 1 | 2 |
| Belt Clip | 1 | 2 |
| Drop-In Charger (DT820A) | – | 1 |
| AC Adaptor (PS-S05C0BU4) | 1 | 1 |
| USB Cable | 1 | 1 |
| OWNERS MANUAL | 1 | 1 |

Optional Accessories

External Speaker MIC (SM-800)

Heavy Duty Earpiece MIC with VOX switch (EM-800)

Air Tube Headset with VOX switch (TM-800)



NOTE

If any of these items are missing from the box, contact your place of purchase, immediately.



Controls and Indicators

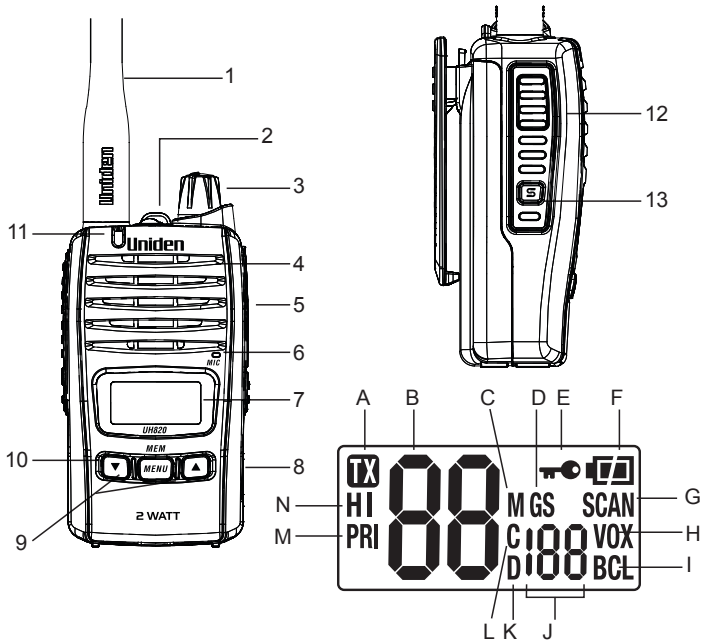

- | | | | | | |
|----|-----------------------|---|----------------------|---|-------------------------|
| 1 | Antenna | A | Transmit | J | CTCSS/DCS |
| 2 | SCAN/MON | B | Channel Indicator | K | Code Indicator |
| 3 | Rotary Vol/Power Knob | C | Scan CH Memory | L | Digitally Coded Squelch |
| 4 | Speaker | D | Group Scan | M | Priority Watch |
| 5 | Accy Speaker MIC Jack | E | Key Lock | N | High Power |
| 6 | Microphone | F | Battery Indicator | | |
| 7 | LCD Display | G | Scanning | | |
| 8 | USB Charge port | H | VOX | | |
| 9 | UP and DOWN Keys | I | Busy Channel Lockout | | |
| 10 | MENU [MEM] Key | | | | |
| 11 | LED | | | | |
| 12 | PTT KEY | | | | |
| 13 | SMART KEY | | | | |

Getting Started

Connect Drop-in Charger with AC Adaptor (UH820-2 only)

Plug one end of the USB cable into the drop-in charger and the other end to the AC adaptor. Plug the AC adaptor into the wall outlet.

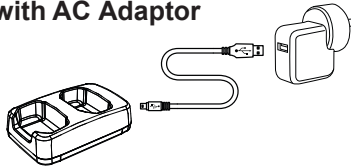

OR...

Connect the USB cable directly to the charge jack of the radio.



NOTE

The drop-in charger are not water proof. Ensure the radio is dry before connecting to the charger. Don't use the chargers when the ambient temperature is below 5° C (37° F) or above 40° C (108° F). If Charge LED didn't light up, please confirm the above temperature.

Attaching the Antenna

Attach the antenna to the radio.
Be sure the antenna is firmly seated.





Getting Started

Attaching the Battery Pack

The UH820 series radios can be powered with a lithium ion battery pack or with optional 3xAA batteries fitted into the battery jacket.

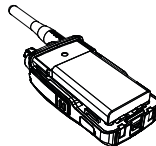

NOTE

The radio can be charged in the drop-in cradle on only when the rechargeable lithium-ion battery is fitted.

1. Remove COVER BATTERY
2. Place the battery pack onto the back of the radio. It will only fit one way.
3. While holding down the locking hook, slide COVER BATTERY onto the back of Radio.
4. Completely slide in and then release the locking hook.



CAUTION

Avoid exposing the Lithium Ion battery, attached or unattached to the radio, in direct sunshine, heated cars, or in areas with temperatures below -20°C (-4°F) or above $+60^{\circ}\text{C}$ ($+140^{\circ}\text{F}$).

Exposing the chemicals contained within the battery pack to temperatures above $+60^{\circ}\text{C}$ ($+140^{\circ}\text{F}$) may cause the battery to rupture, fail or reduce performance.

In case of exposure to cell contents, wash the affected area thoroughly, and seek medical attention.

Additional battery cautions should be applied as described on p.2.

To Attach the Belt Clip:

Slide the belt clip into the catch until it snaps into place.

To Remove the Belt Clip:

Pinch and hold the belt clip latch and then slide the belt clip up and out of the catch.





Getting Started

Charging the Battery Pack

Your radio is powered by a specially designed Lithium Ion battery pack.

- Before operating the radio, charge the Lithium Ion battery pack for 4 hours without interruption in the drop-in charger.



NOTE

For the initial battery charge, make sure the radio is off for optimum charging.

The drop-in charger can charge the Lithium Ion battery pack attached to the radio, in the front charging slot.

1. Place the radio, in the drop-in charger.
2. The red LED illuminates and stays ON, until fully charged.
 - The charger won't overcharge the battery packs.
3. The green LED illuminates and stays ON after charging is completed.
 - **Do not transmit when the radio is charging; in the drop-in charger or when connected to the DC adaptor!**
 - You can monitor incoming calls while the radio is in the drop-in charger.



Getting Started

Battery Level Display

The BATTERY icon at the top of the screen indicates the battery level at all times. The battery level is displayed in 4 levels.

LEVEL 4
Battery 100% full



LEVEL 3
Battery approx. 40% capacity



LEVEL 2
Low Battery

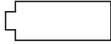

LEVEL 1
(flashing)
Empty Battery



At LEVEL 2, low battery alert will be sounded every 15 minutes.



NOTE

When **(PTT)** is pressed at Level 1, an error tone sounds and transmission is disabled. Once at Level 1 the unit will automatically shutdown after 30 seconds.



NOTE

Recharge the battery at any time. When the battery is empty, it will take up to 4 hours.

Battery Life: up to 21 hours.
This is based on the following Duty Cycle:

Transmit (Low Power) 5%
Receive 5%
Stand-by 90%

LED Status

| LED | What it Indicates |
|-------------|---------------------|
| Green | Start Up/Power on |
| Green Flash | Monitor mode |
| Green | Receiving Signal |
| Red | Transmitting signal |

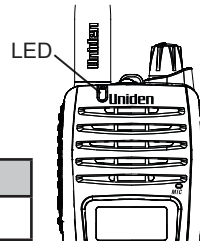

Getting Started

Accessory Jack Cover

Make sure the Accessory Jack Cover is firmly pushed in to maintain submersible rating.

Connecting the Earpiece MIC or SPKR/MIC.

Release the Accessory Jack Cover to plug in the **Earpiece MIC** or **SPKR/MIC**.

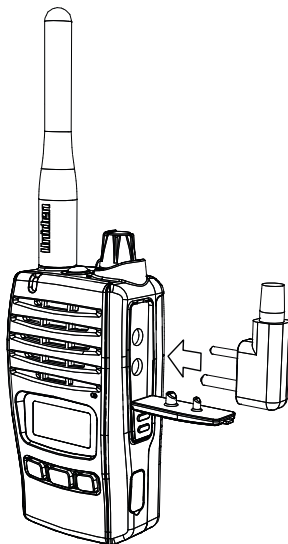



Operation

Power On/Off

1. To turn the unit **ON**, rotate the **[ON/OFF VOL]** knob clockwise. A channel number and battery level should appear on the display.
2. To turn the unit **OFF**, rotate the **[ON/OFF VOL]** knob counter-clockwise. The display will disappear.

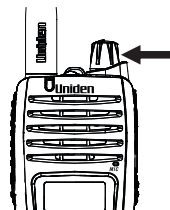

Volume

Rotate the **[ON/OFF VOL]** knob clockwise or counter-clockwise to adjust speaker volume to desired listening level.

Setting The Squelch

The squelch is used to eliminate any annoying background noise when there are no signals present.

Auto/Sq 1 - max sensitivity (min squelch)
Sq 5 - min sensitivity (max/tight squelch)



1. Press **[MENU/MEM]** 2 times. **Sq** and the current squelch level will flash on the display.
2. Use **▲** or **▼** to change the squelch level from Auto/1 to 5.
3. Press & hold **[MENU/MEM]** to save and exit.





Operation

Selecting A Channel

Press ▲ or ▼ to select the desired channel.



NOTE

If you press and hold ▲ or ▼ the channel numbers will scroll rapidly.

To Transmit and Receive

The radio uses the UHF-CB Channels. For your reference a list of the available channels and corresponding frequencies is printed on p.28 - p.29. (Channels 22 and 23 are for telemetry and telecommand applications, channels 61, 62 and 63 are for future use. TX is inhibited on these channels.)

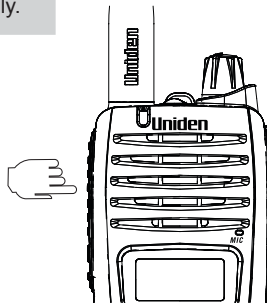

The maximum RF transmit power is 2.0W.
(see Transmit Power Select, p.15.)

1. Before you transmit, listen for activity on the selected channel.
2. When the channel is clear;
 - Press **[PTT]** to transmit at the selected Hi/Lo transmit power, **TX** appears on the LCD and LED lights red during transmit.

Hold the radio with microphone approximately 5cm in front of your mouth with the antenna at approximately 45° angle away from your head. Speak in a clear, normal conversational voice.

4. When you have finished speaking, release **[PTT]** and listen for a response then TX disappears on the LCD. LED lights green while receiving a signal.





Operation

To Operate In Duplex Mode (Repeaters)

The Duplex function enables you to access local repeater stations.



NOTE

You can only activate Duplex on CH01-CH08 and CH41-CH48.

UHF CB Repeaters are used to retransmit or relay your signal. Repeaters will extend the range of your radio and overcome the shielding effect caused by solid obstructions.

Eg. CH01 is being used in your area for repeater use.

1. Press **[MENU/MEM]** 4 times.
2. Press **▲** or **▼** to change the selection. **r** appears for CH01-CH08 and **n** appears for CH41-CH48 when duplex is selected.
3. Press & hold **[MENU/MEM]** to save and exit.



NOTE

Contact your retailer for a list of repeaters available in your area.

Operation with the aid of a Repeater

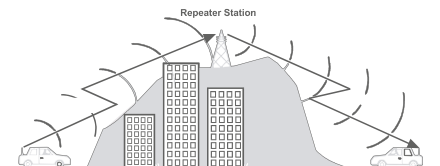



Operation

Transmit Power Select

This radio has two transmit power levels:

Hi: 2.0 Watt.

Lo: 0.5 Watt.

To change your transmit power level:

1. Press **[MENU/MEM]**.
2. Press **▲** or **▼** to change the setting to **Hi** or **Lo**.
3. Press & hold **[MENU/MEM]** to save and exit.



TX Power High



TX Power Low

Smart-key Function

The smart key **[S]** provides one touch access to one of these functions; Instant Channel, Call Tone or **Key Lock**.

Press & hold **[S]** to change the smart key function between the three options.

Scanning

There are 2 scanning modes;

Open Scan (OS) and

Group Scan (GS)

During SCAN the radio only checks channels or frequencies that are in the SCAN Memory, which are indicated by the M (memory) icon. The radio maintains two SCAN Memories; one for Open Scan (OS) mode and the other for Group Scan (GS) mode, to give you flexibility and allow you to use the radio more effectively.



Operation

To initiate scanning,

1. Press **[SCAN/MON]** to start Scanning.
2. The SCAN icon flashes.
3. The scan direction can be changed at any time by pressing **▼** or **▲**.
4. Press **[SCAN/MON]** to stop Scanning.

To select scan mode,

1. Press **[MENU/MEM]** 7 times.
2. Press **▲** or **▼** to change the setting to SCAN (Open Scan) or GS SCAN (Group Scan).
3. Press & hold **[MENU/MEM]** to save and exit.
The selected scan mode appears on the display.

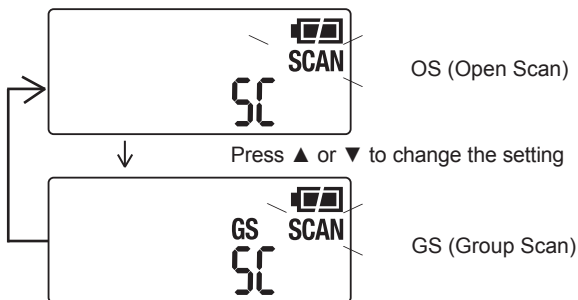



Operation

Add/Remove Channels from Memory

1. Select which Scanning Mode you wish to use on the channel OS or GS Mode.



NOTE

OS is indicated by the absence of the GS icon.

2. Select the channel you want to store by pressing ▼ or ▲.
3. Press and hold **[MENU/MEM]** to store.
4. To remove the channel from Memory, Press and hold **[MENU/MEM]** to remove. M icon disappears.

Open Scan (OS) mode

Open Scan is the default scan mode.

All UHF-CB have been added to the OS SCAN Memory for convenience. To add/remove channels from OS SCAN Memory, refer to previous section.

Allows continuous scanning of all selected channels. If an active channel is found, scanning will stop on that channel. If the received signal ceases, the unit will wait 2 seconds for the signal to return, otherwise scanning resumes.

After transmission in scan mode, the scan mode will be cancelled.





Operation

To select OS scan mode,

1. Press **[MENU/MEM]** 7 times.
2. Press **▲** or **▼** to change the setting to SCAN (Open Scan).
3. Press & hold **[MENU/MEM]** to save and exit.



NOTE

OS Mode is indicated by the absence of the GS icon.



NOTE

If SCAN is deactivated while on an active channel, the radio will stay on that active channel. If no channels are active, the radio will reinstate the starting channel.

Group Scan (GS) Mode

Channels must be stored to the GS SCAN Memory before group scan can start. To add/remove channels from GS SCAN Memory, refer to p.17.

Includes the accessory feature Priority Watch which allows you to monitor the Instant Priority Channel while scanning (see p.19 for setting Instant Priority Channel and p.19 to turn on Priority Watch).

If scanning stops on a channel which is not a Priority Channel, UHF CB Radio will continue monitoring the Priority Channel for activity while listening to the active one.

To select GS scan mode,

1. Press **[MENU/MEM]** 7 times.
2. Press **▲** or **▼** to change the setting to GS SCAN (Group Scan)
3. Press & hold **[MENU/MEM]** to save and exit.





Operation

Priority Channel Watch During Group Scan

The feature allows user to monitor the Instant Priority channel every 1.5 seconds during Group Scanning.

1. Press **[MENU/MEM]** 5 times. **PRI** setting flashes.
2. Press **▲** or **▼** to change the setting on or off.
3. Press & hold **[MENU/MEM]** to save and exit.

Drop-Out Delay

While scanning, the radio stops at a busy channel and receives a signal. When the received signal is over, the unit will wait for 2 seconds for the return of the signal, otherwise, the radio resumes scanning.

Programming the Instant Priority Channel

1. Press **[MENU/MEM]** 6 times. **PRI** and current channel setting flashes.
2. Press **▲** or **▼** to select the desired channel.
3. Press & hold **[MENU/MEM]** to save and exit.

Recalling the Instant Channel

Press **[S]** when Smart Key is set to Instant Channel function.



Operation

Monitor

This feature enables users to listen in for weak signals on the current channel at the press of a button.

To use monitor,

- For continuous listening.
Press and hold **[SCAN/MON]**

A beep tone will be heard and the receiver circuit will stay open, letting in both the noise & weak signals.

- **RX** LED flashes green.
- To return to normal receive mode
Press **[SCAN/MON]**

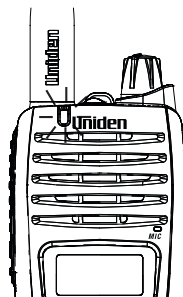

CTCSS

CTCSS is a feature that allows a group to talk to each other without hearing other users on the same channel.

1. Select desired channel.
2. Press **[MENU/MEM]** 3 times.
DCS/CTCSS setting flashes.
3. Press **▲** or **▼** to change the selection.
4. Press & hold **[MENU/MEM]** to save and exit.



NOTE

Select **oF** to turn DCS/CTCSS off for the selected channel.



Operation

DCS

DCS is a digital extension of CTCSS. It provides 104 extra, digitally coded, squelch codes that follow after the 38 CTCSS codes. CTCSS 1-38, followed by DCS 1-104.



Follow the steps for changing CTCSS code but select DCS code as desired.



NOTE

Channel 05 and 35 are used for emergency channels. CTCSS and DCS will not operate on these two channels.

VOX

VOX is the automatic transmitting function without pressing the PTT key.

VOX appears when VOX level setting is from 1 to 5.

1. Press **[MENU/MEM]** 8 times.

VOX setting flashes.

2. Press **▲** or **▼** to select the desired setting.
The 6 VOX levels are from 1 (low sensitivity) to 5 (high sensitivity) and Off.

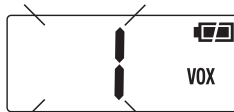

3. Press & hold **[MENU/MEM]** to save and exit.





Operation

Busy Channel Lockout

This feature prevents accidental transmission on a busy channel. For example, BCL is used when CTCSS or DCS is selected to prevent transmission when the radio detects a transmission from another unit using the same CTCSS or DCS code.

1. Press **[MENU/MEM]** 9 times.
BCL setting flashes.
2. Press **▲** or **▼** to change the setting on or off.
3. Press & hold **[MENU/MEM]** to save and exit.

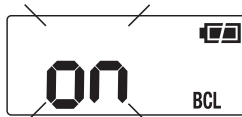

Call Tone

The radio is equipped with 5 selectable call tones that will be transmitted when **[S]** is pressed when Smart Key is set to Call Tone function.

1. Press **[MENU/MEM]** 10 times.
CL setting flashes.
2. Press **▲** or **▼** to change the selection.
The 5 call tones are CL 1 to CL 5.
A sample of the call tone is sounded when selected.
3. Press & hold **[MENU/MEM]** to save and exit.



NOTE

Current regulations require calling tones to be restricted to one transmission per minute. If a second transmission is attempted within one minute then an error tone will sound.



Operation

Roger Beep

Roger Beep is a BEEP that is sent to notify the end of transmission (both PTT and VOX transmission.) Roger Beep can be heard through the speaker when Key Beep is on. Roger Beep is transmitted even if Key Beep is turned off. However, Roger Beep will not be heard from the speaker.

1. Press **[MENU/MEM]** 11 times.
rb setting flashes.
2. Press **▲** or **▼** to change the setting on or off.
3. Press & hold **[MENU/MEM]** to save and exit.



Key Beep

Assures the user that the keypad has been properly pressed by emitting a beep tone. This tone can be switched on or off.

1. Press **[MENU/MEM]** 12 times.
bP setting flashes.
2. Press **▲** or **▼** to change the setting on or off.
3. Press & hold **[MENU/MEM]** to save and exit.





Operation

Keypad Lock

To prevent accidental entries, you can lock the keypad. Press and hold **[S]** repeatedly to cycle through the Smart Key modes until the  appears.

To unlock the keypad, press and hold **[S]** again for 1.5 seconds. The  disappears.



NOTE

When the keypad Lock is active, an error tone will be heard if you attempt to press any key, except for the following key function; **(PTT)**.

Back Lighting

The Liquid Crystal Display (LCD) is backlit for easy viewing at night or in low light situations. The back lighting automatically switches ON every time a key (except PTT) is pressed. It turns OFF 5 seconds after the last key is pressed.





CTCSS Codes and Frequencies

| Code No. | Frequency (Hz) | Code No. | Frequency (Hz) |
|----------|----------------|----------|----------------|
| "oF" | OFF | 20 | 131.8 |
| 1 | 67.0 | 21 | 136.5 |
| 2 | 71.9 | 22 | 141.3 |
| 3 | 74.4 | 23 | 146.2 |
| 4 | 77.0 | 24 | 151.4 |
| 5 | 79.7 | 25 | 156.7 |
| 6 | 82.5 | 26 | 162.2 |
| 7 | 85.4 | 27 | 167.9 |
| 8 | 88.5 | 28 | 173.8 |
| 9 | 91.5 | 29 | 179.9 |
| 10 | 94.8 | 30 | 186.2 |
| 11 | 97.4 | 31 | 192.8 |
| 12 | 100.0 | 32 | 203.5 |
| 13 | 103.5 | 33 | 210.7 |
| 14 | 107.2 | 34 | 218.1 |
| 15 | 110.9 | 35 | 225.7 |
| 16 | 114.8 | 36 | 223.6 |
| 17 | 118.8 | 37 | 241.8 |
| 18 | 123.0 | 38 | 250.3 |
| 19 | 127.3 | | |



DCS Codes Table

| Code No. | DCS Code (Octal) | Code No. | DCS Code (Octal) | Code No. | DCS Code (Octal) |
|----------|------------------|----------|------------------|----------|------------------|
| 1 | 023 | 36 | 223 | 71 | 445 |
| 2 | 025 | 37 | 225 | 72 | 446 |
| 3 | 026 | 38 | 226 | 73 | 452 |
| 4 | 031 | 39 | 243 | 74 | 454 |
| 5 | 032 | 40 | 244 | 75 | 455 |
| 6 | 036 | 41 | 245 | 76 | 462 |
| 7 | 043 | 42 | 246 | 77 | 464 |
| 8 | 047 | 43 | 251 | 78 | 465 |
| 9 | 051 | 44 | 252 | 79 | 466 |
| 10 | 053 | 45 | 255 | 80 | 503 |
| 11 | 054 | 46 | 261 | 81 | 506 |
| 12 | 065 | 47 | 263 | 82 | 516 |
| 13 | 071 | 48 | 265 | 83 | 523 |
| 14 | 072 | 49 | 266 | 84 | 526 |
| 15 | 073 | 50 | 271 | 85 | 532 |
| 16 | 074 | 51 | 274 | 86 | 546 |
| 17 | 114 | 52 | 306 | 87 | 565 |
| 18 | 115 | 53 | 311 | 88 | 606 |
| 19 | 116 | 54 | 315 | 89 | 612 |
| 20 | 122 | 55 | 325 | 90 | 624 |
| 21 | 125 | 56 | 331 | 91 | 627 |
| 22 | 131 | 57 | 332 | 92 | 631 |
| 23 | 132 | 58 | 343 | 93 | 632 |
| 24 | 134 | 59 | 346 | 94 | 654 |
| 25 | 143 | 60 | 351 | 95 | 662 |
| 26 | 145 | 61 | 356 | 96 | 664 |
| 27 | 152 | 62 | 364 | 97 | 703 |
| 28 | 155 | 63 | 365 | 98 | 712 |
| 29 | 156 | 64 | 371 | 99 | 723 |
| 30 | 162 | 65 | 411 | 100 | 731 |
| 31 | 165 | 66 | 412 | 101 | 732 |
| 32 | 172 | 67 | 413 | 102 | 734 |
| 33 | 174 | 68 | 423 | 103 | 743 |
| 34 | 205 | 69 | 431 | 104 | 754 |
| 35 | 212 | 70 | 432 | | |



UHF-CB Channel Guidelines



NOTE

Always listen on a channel (or observe the receive signal level meter) to ensure it is not already being used before transmitting.

Channels 5 and 35 are used for emergency channels.

CTCSS, DCS will not operate on these channels.

Please follow these guidelines for channel use in Australia:

- Channels 05 and 35 are Emergency Channels.
- Channel 11 is a Calling Channel.
- Channels 22 and 23 are for telemetry and telecommand applications, channels 61, 62 and 63 are for future use and TX is inhibited on these channels.

General communication is accepted on all other channels with these guidelines:

- Channel 40 - road channel (Australia).
- Channels 01-08 (and 31-38), and Channels 41-48 (and 71-78) are repeater channels.

Important information - 80 Channel UHF-CB channel expansion

To provide all users additional channel capacity within the UHF-CB Band the ACMA introduced narrowband channel use. This allows for additional channels to be added, up to 80 Channels.

This simply means that the new narrowband radio you have purchased will have more channels than older radios. Please refer to the guidelines above and the channel chart for further channel information.

A list of currently authorised channels can also be obtained from the ACMA website in Australia and the MBIE website in New Zealand.



NOTE

Interference / Poor Audio

When a new narrowband radio receives a signal from an older wideband radio the speech may sound loud.

Narrowband radios operating on CH41 - CH80 may encounter interference from nearby wideband radios transmitting on high power on an adjacent channel (frequency).

When an older wideband radio receives a signal from a new narrowband radio the speech may sound quiet - the wideband radio user simply adjusts their radio volume for best performance.

The above situations are not a fault of the radio but a symptom of mixed wideband and narrowband radios in current use. It is expected that as older wideband radios are phased out this issue will be eliminated.





UHF-CB Channels and Frequencies

| CH No. | Simplex Mode Transmit / Receive Frequency (MHz) | Duplex Mode Transmit Frequency (MHz) | CH No. | Simplex Mode Transmit / Receive Frequency (MHz) |
|--------|---|--------------------------------------|--------|---|
| 1 | 476.425 | 477.175 (CH31) | 21 | 476.925 |
| 2 | 476.450 | 477.200 (CH32) | 22 | 476.950 (RX only) |
| 3 | 476.475 | 477.225 (CH33) | 23 | 476.975 (RX only) |
| 4 | 476.500 | 477.250 (CH34) | 24 | 477.000 |
| 5 | 476.525 | 477.275 (CH35) | 25 | 477.025 |
| 6 | 476.550 | 477.300 (CH36) | 26 | 477.050 |
| 7 | 476.575 | 477.325 (CH37) | 27 | 477.075 |
| 8 | 476.600 | 477.350 (CH38) | 28 | 477.100 |
| 9 | 476.625 | | 29 | 477.125 |
| 10 | 476.650 | | 30 | 477.150 |
| 11 | 476.675 | | 31 | 477.175 |
| 12 | 476.700 | | 32 | 477.200 |
| 13 | 476.725 | | 33 | 477.225 |
| 14 | 476.750 | | 34 | 477.250 |
| 15 | 476.775 | | 35 | 477.275 |
| 16 | 476.800 | | 36 | 477.300 |
| 17 | 476.825 | | 37 | 477.325 |
| 18 | 476.850 | | 38 | 477.350 |
| 19 | 476.875 | | 39 | 477.375 |
| 20 | 476.900 | | 40 | 477.400 |





UHF-CB Channels and Frequencies

| CH No. | Simplex Mode Transmit / Receive Frequency (MHz) | Duplex Mode Transmit Frequency (MHz) | CH No. | Simplex Mode Transmit / Receive Frequency (MHz) |
|--------|---|--------------------------------------|--------|---|
| 41 | 476.4375 | 477.1875 (CH 71) | 61 | 476.9375 (RX only) |
| 42 | 476.4625 | 477.2125 (CH 72) | 62 | 476.9625 (RX only) |
| 43 | 476.4875 | 477.2375 (CH 73) | 63 | 476.9875 (RX only) |
| 44 | 476.5125 | 477.2625 (CH 74) | 64 | 477.0125 |
| 45 | 476.5375 | 477.2875 (CH 75) | 65 | 477.0375 |
| 46 | 476.5625 | 477.3125 (CH 76) | 66 | 477.0625 |
| 47 | 476.5875 | 477.3375 (CH 77) | 67 | 477.0875 |
| 48 | 476.6125 | 477.3625 (CH 78) | 68 | 477.1125 |
| 49 | 476.6375 | | 69 | 477.1375 |
| 50 | 476.6625 | | 70 | 477.1625 |
| 51 | 476.6875 | | 71 | 477.1875 |
| 52 | 476.7125 | | 72 | 477.2125 |
| 53 | 476.7375 | | 73 | 477.2375 |
| 54 | 476.7625 | | 74 | 477.2625 |
| 55 | 476.7875 | | 75 | 477.2875 |
| 56 | 476.8125 | | 76 | 477.3125 |
| 57 | 476.8375 | | 77 | 477.3375 |
| 58 | 476.8625 | | 78 | 477.3625 |
| 59 | 476.8875 | | 79 | 477.3875 |
| 60 | 476.9125 | | 80 | 477.4125 |





Warranty

UNIDEN UH820 series CB Transceiver

IMPORTANT: Satisfactory evidence of the original purchase is required for warranty service.

Please refer to our Uniden website for any details or warranty durations offered in addition to those contained below.

Warrantor: The warrantor is Uniden Australia Pty Limited ABN 58 001 865 498 (“Uniden”).

Terms of Warranty: Uniden Aust warrants to the original retail purchaser only that the UH820 series (“the Product”), will be free from defects in materials and craftsmanship for the duration of the warranty period, subject to the limitations and exclusions set out below.

Warranty Period: This warranty to the original retail purchaser is only valid in the original country of purchase for a Product first purchased either in Australia or New Zealand.

| | |
|----------------------------|---------|
| Product | 3 Years |
| Battery Pack & Accessories | 1 Year |

If a warranty claim is made, this warranty will not apply if the Product is found by Uniden to be:

- (A) Damaged or not maintained in a reasonable manner or as recommended in the relevant Uniden Owner’s Manual;
- (B) Modified, altered or used as part of any conversion kits, subassemblies or any configurations not sold by Uniden;
- (C) Improperly installed contrary to instructions contained in the relevant Owner’s Manual;
- (D) Repaired by someone other than an authorised Uniden Repair Agent in relation to a defect or malfunction covered by this warranty; or
- (E) Used in conjunction with any equipment, parts or a system not manufactured by Uniden.

Parts Covered: This warranty covers the Product and included accessories.

User-generated Data: This warranty does not cover any claimed loss of





Warranty

or damage to user-generated data (including but without limitation phone numbers, addresses and images) that may be stored on your Product.

Statement of Remedy: If the Product is found not to conform to this warranty as stated above, the Warrantor, at its discretion, will either repair the defect or replace the Product without any charge for parts or service. This warranty does not include any reimbursement or payment of any consequential damages claimed to arise from a Product's failure to comply with the warranty.

Our goods come with guarantees that cannot be excluded under the Australian Consumer Law. You are entitled to a replacement or refund for a major failure and for compensation for any other reasonably foreseeable loss or damage. You are also entitled to have the goods repaired or replaced if the goods fail to be of acceptable quality and the failure does not amount to a major failure.

This warranty is in addition to and sits alongside your rights under either the COMPETITION AND CONSUMER ACT 2010 (Australia) or the CONSUMER GUARANTEES ACT (New Zealand) as the case may be, none of which can be excluded.



Procedure for obtaining warranty service: Depending on the country in which the Product was first purchased, if you believe that your Product does not conform with this warranty, you should deliver the Product, together with satisfactory evidence of your original purchase (such as a legible copy of the sales docket) to Uniden at the address shown below. You should contact Uniden regarding any compensation that may be payable for your expenses incurred in making a warranty claim. Prior to delivery, we recommend that you make a backup copy of any phone numbers, images or other data stored on your Product, in case it is lost or damaged during warranty service.



UNIDEN AUSTRALIA PTY LTD

Service Division

Phone: 1300 366 895

Email: custservice@uniden.com.au





THANK YOU FOR BUYING A UNIDEN PRODUCT.



Uniden®

© 2018 Uniden Australia Pty Limited. Printed in Vietnam.
U01UT970AZZ(1)

